

FN300 – Thermal Flow Switch with LED Digital Display

- ▶ 4-digit LEDs
- ▶ Flow velocity/percentage display
- ▶ Wide measuring range
- ▶ Measuring span programmable
- ▶ PNP / NPN programmable
- ▶ 4..20mA/0...20mA/1...5V/0...5V output programmable
- ▶ Rotatable indicator, easy to read, robust display



Based on thermodynamic principle, FN300 features 2 temperature sensors inside the probe: one for medium temperature, the other one is heated a few degrees up compared to the medium into which it projects. When the medium flows, the heat generated in the sensor is conducted away by the medium. The difference between these two sensors can be measured to get the flow rate. Compared to traditional products, FN300 offers wider measuring range, less temperature drifting, as well as percentage or flow velocity display. All-metal housing, highlighted digital LED, dual-key and user-friendly interface, multiple process connections, 330° rotatable indicator.

Specifications

Measuring Range	
Water	1...200cm/s
Oil	3...300cm/s
Air	20...2000cm/s
Applicable Medium	Water, oil and gas which is compatible with 316 stainless steel
Repeatability	1%@<0.6m/s; 3%@<1.5m/s; 10%@>1.5m/s (for water)
Pressure Rating	100bar (200bar selectable)
Initialization Time	1...8s
Response Time	2s typical
Power Supply	24±10%Vdc
Current Consumption	≤100mA (power supply 24Vdc, no-load)
Switching Output	
Output	Push-pull (compatible with PNP / NPN); NC / NO configurable
S1, S2 Output Current	<500mA
Voltage Drop	<1V
Current Analog Output	
Output	3-wire 0...20mA / 4...20mA programmable
Load RA	RA≤0.5KΩ
Voltage Analog Output	
Output	3-wire 0...5V / 1...5V programmable
Load RA	RA>10KΩ
Wiring Protection	Reverse polarity, overvoltage and short-circuit
Display	
Design	8mm height, red 4-digit LED
Display Range	-1999...9999
Temperature	
Operating	-40...85°C
Medium	-20...85°C, up to 130°C (not more than 2 hours)
Material	
Housing	304 stainless steel
Probe	304 stainless steel/316 stainless steel (for the sanitary)
Protection Class	IP67
Electrical Connection	M12x1 plug

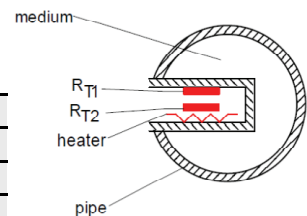

Applications

- ▶ Hydraulic system
- ▶ Lubrication system
- ▶ Pump protection
- ▶ Cooling water monitoring
- ▶ Venting systems
- ▶ Water treatment
- ▶ Leaking test
- ▶ Machinery manufacture
- ▶ Equipment manufacture
- ▶ Engineering project

Set Panel

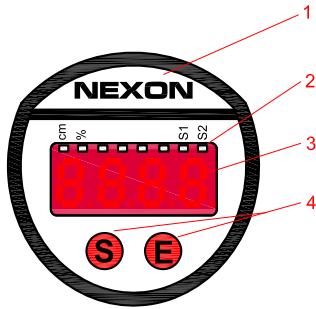

- 1 - LOGO
- 2 - 8 state lights
- 3 - 4-digit LED display window
- 4 - Keys

S + E	Press and hold for 2 seconds to enter setting mode/verification
S	Shift down the menu / change values
E	Shift up the menu / Change values

Menu

Display	Item	Description	Options
unit	unit	unit	cm/s or %
SP1	SP1	set point of output 1	2% ...100% of F.S.
rP1	rP1	reset point of output 1	lower limit ... 98% of F.S.
out1	out1	output mode	hysteresisNC/NO window NC/NO
SP2	SP2	set point of output 2	2% ...100% of F.S.
rP2	rP2	reset point of output 2	lower limit ...98% of F.S.
out2	out2	output mode	hysteresisNC/NO window NC/NO
SFun	sfun	output function	PNP / NPN

		Description	Options
Aout	Aout	current analog output	0...20mA or 4...20mA
		voltage analog output	0...5V or 1...5V
Ast	Ast	analog output start point	lower limit ...75% of F.S.
AEd	AEd	analog output end point	25%...100% of F.S.
Sto	Sto	Save	Yes/No

Functional Specifications

Hysteresis Mode

The hysteresis keeps the switching output stable if the flow velocity fluctuates around the setpoint. Output switches when rising flow velocity reaches set point (SP1); As flow velocity falls, the output switches back only if the reset point (rP1) is reached.

Hysteresis Mode

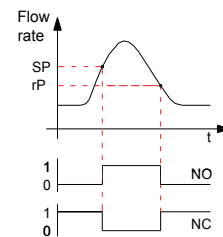

Window Mode

The window function allows the monitoring of a defined range. If the flow velocity is between set point (SP1) and reset point (rP1), the output is activated (NO), otherwise it is deactivated (NC).

Window Mode

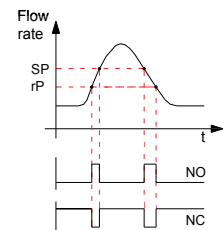

Dimensions in inches (mm)

FLOW

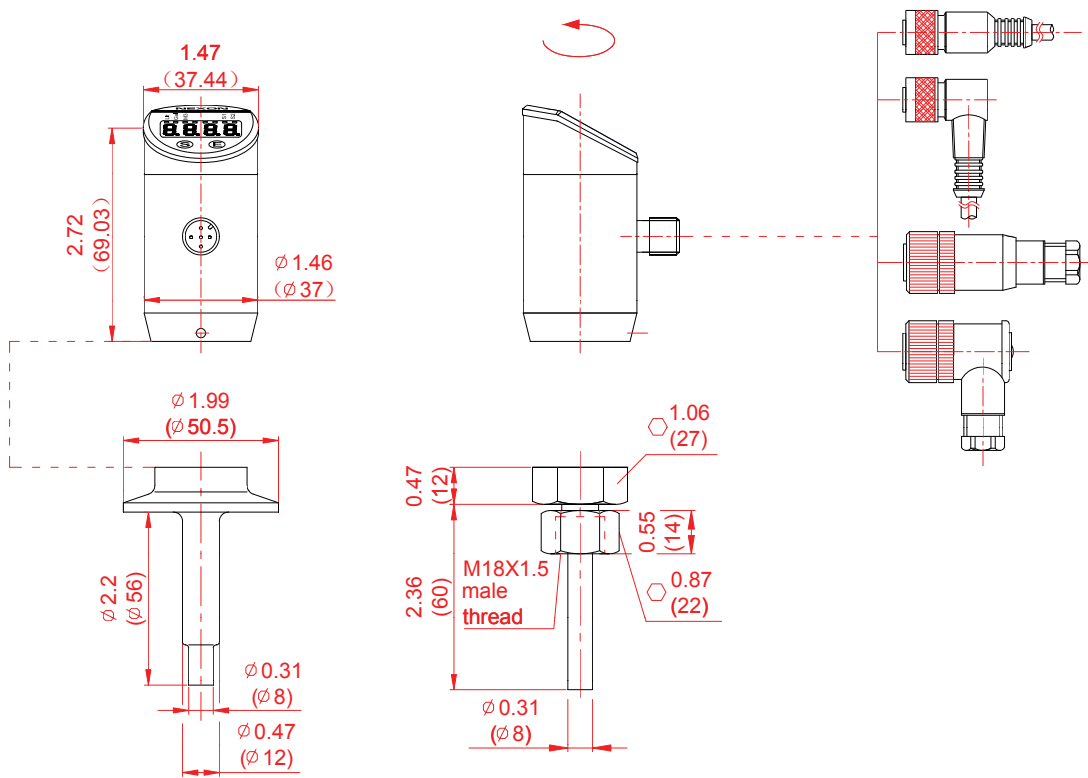

Probe with S50 thread
(for the sanitary)

Probe with F18 thread

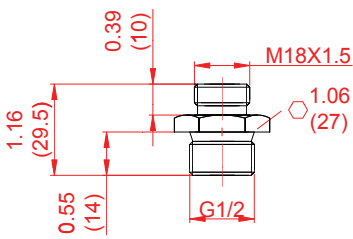

FG12 accessory

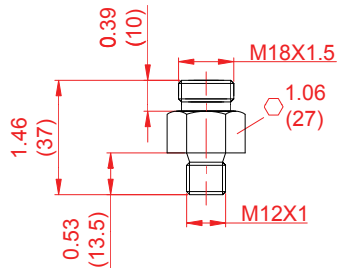

FM12 accessory

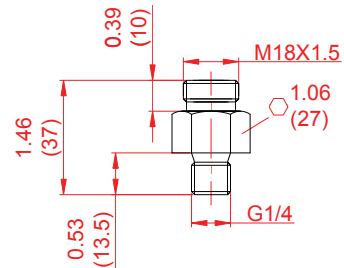

FG14 accessory

Note: One of the connectors FG12, FM12 or FG14 must be ordered for sealing purpose if probe is F18.

Wiring

Signal	Plug	Cable
U+	1	Brown
U-	3	Blue
Switching output 1	4	Black
Switching output 2	2	White
Analog output (Current or Voltage)	5	Gray

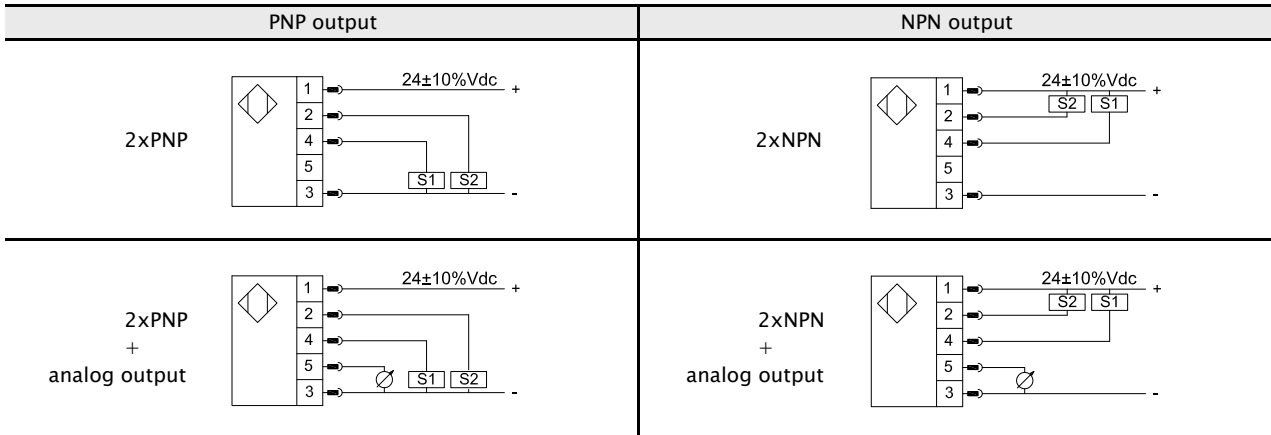
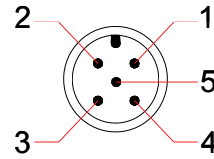

Order Code

FN : Thermal flow switch with digital display
300 : Series#-standard
Probe type : **G14M :** G1/4 male thread
G12M : G1/2 male thread
SC50 : Sanitary type SC50
F18 : Standard F18

FN	300/	F18	21	M50	S
-----------	-------------	------------	-----------	------------	----------

20 : 2 switching outputs
21 : 2 switching outputs +
 1 analog (0...20/4...20mA) output
22 : 2 switching outputs +
 1 analog (0...5/1...5V) output
MXXX : Probe length (metric system) L=XXX mm
IXXXX : Probe length (english system) L=XXX inch
S : M12X1 with 5-pin plug

Special Order on Request

- ▶ Probe for corrosive medium
- ▶ Probe length
- ▶ Radiator for high temperature medium
- ▶ Electrical and / or process connection