

# XINVAL

## Quick Connects

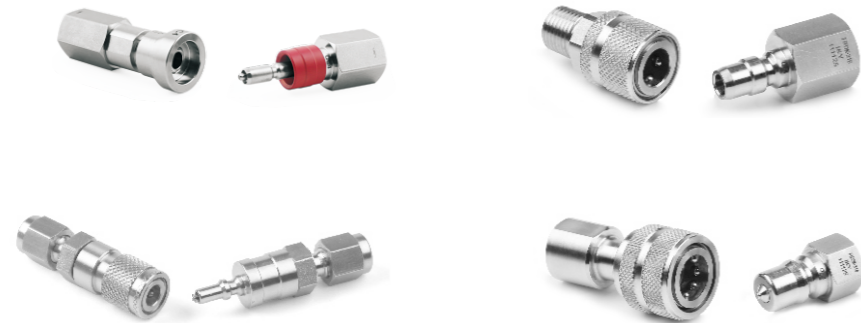

### QC Series

#### Features

- Working pressure up to: 3000 psig (207 bar)
- Materials: Stainless steel or brass
- Reliable, leak-tight O-ring seal for vacuum or pressure systems
- Interchangeable with other key manufacturers' products
- Single-end shutoff, double-end shutoff and full-Fow model available
- Push-to-connect coupling to enable quick and easy operation
- Locking mechanism with large contact area to ensure reliable stem retainment
- Stem protector, body protector and keyed options available

#### Single-end Shutoff (SES)

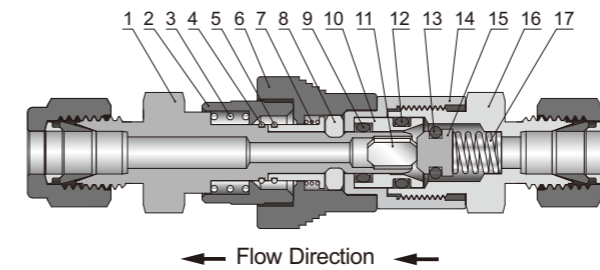

#### Double-end Shutoff (DES) - Red Stem Sleeve

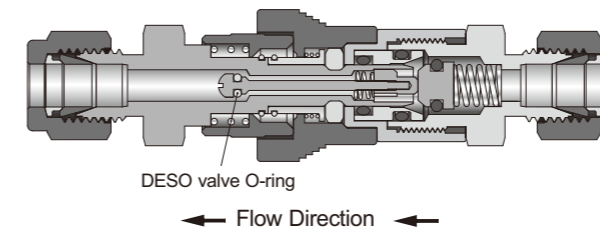

#### Full-Fow Quick-Connects

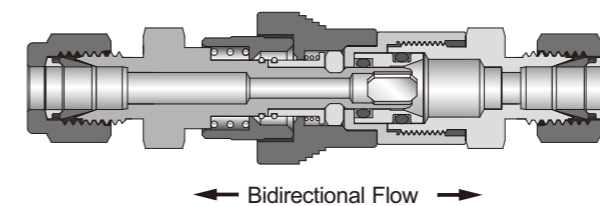

### Standard Materials of Construction

Item	Component	Stainless Steel	Brass
		Material Grade/ASTM Specification	
1	Stem	316 SS/A479	Brass C36000/B16
2	DESO stem sleeve	PTFE-coated 316L SS/A479	PTFE-coated Brass C36000/B16
	SESO stem sleeve	316L SS/A479	Brass C36000/B16
3	Springs	316 SS/A313	
4	Snap rings	316 SS/A313	
5			
6	Body sleeve	316L SS/A479	Brass C36000/B16
7	Springs	316 SS/A313	
8	Locking dogs	Xylan®-coated 316 SS powdered metal	
9	O-rings	Fluorocarbon FKM	Buna N
10	Sliding sleeve	316 SS/A479	Brass C36000/B16
11	SESO stem insert	316 SS/A240	Brass C26000/B36
12	O-rings	Fluorocarbon FKM	Buna N
13	O-rings	Fluorocarbon FKM	Buna N
14	Housing	316L SS/A479	Brass C36000/B16
15	Plug	316 SS/A479	Brass C36000/B16
16	Body	316 SS/A479	Brass C36000/B16
17	Springs	316 SS/A313	
18	Lubricants	Silicone-based	

### Insertion Depth

Series	Insertion Depth	
	SESO	DESO
	in. (mm)	in. (mm)
QC4	1.09 (27.7)	1.15 (29.2)
QC6	1.18 (30.0)	1.30 (33.0)
QC8	1.48 (37.6)	1.68 (42.7)

In order to measure overall length in the coupled position, the insertion depth should be deducted from any overall stem and body combination length.

### Spillage and Air Inclusion

**Spillage** - the amount of system fluid that escapes when a quick-connect is uncoupled (DESO only)

**Air Inclusion** - the amount of air trapped between the body and stem that enters the system when a quick-connect is coupled (DESO only)

Series	Spillage, cm <sup>3</sup>	Air Inclusion, cm <sup>3</sup>
QC4	0.3	0.3
QC6	1.0	1.0
QC8	3.0	3.0

## Pressure-Temperature Ratings

Pressure rating restrictions apply when coupling and uncoupling (DESO only). Refer to the tables below for specific data.

### QC4 Series

Material	316 SS			Brass
O-Ring Material	Fluorocarbon FKM	Ethylene propylene	Perfluoro-carbon FFKM	Buna N
Temperature °F (°C)	Pressure Rating, psig(bar)			
	Coupled			
-50 (-45)	—	3000 (206)	—	—
0 (-17)	3000 (206)	3000 (206)	3000 (206)	2000 (137)
10 (-12)	3000 (206)	3000 (206)	3000 (206)	2000 (137)
60 (15)	3000 (206)	3000 (206)	3000 (206)	2000 (137)
100 (37)	3000 (206)	3000 (206)	3000 (206)	2000 (137)
150 (65)	2750 (189)	2750 (189)	2750 (189)	1300 (895)
200 (93)	2300 (158)	2300 (158)	2300 (158)	700 (48)
250 (121)	1850 (127)	1850 (127)	1850 (127)	300 (20.6)
300 (148)	1400 (96.4)	1400 (96.4)	1400 (96.4)	—
350 (176)	950 (65.4)	—	950 (65.4)	—
400 (204)	500 (34.4)	—	500 (34.4)	—
500 (260)	—	—	150 (10.3)	—
	Uncoupled and When Coupling and Uncoupling			
70 (20)	250 (17.2)			

### QC8 Series

Material	316 SS			Brass
O-Ring Material	Fluorocarbon FKM	Ethylene propylene	Perfluoro-carbon FFKM	Buna N
Temperature °F (°C)	Pressure Rating, psig(bar)			
	Coupled			
-50 (-45)	—	750 (51.6)	—	—
0 (-17)	750 (51.6)	750 (51.6)	750 (51.6)	500 (34.4)
10 (-12)	750 (51.6)	750 (51.6)	750 (51.6)	500 (34.4)
60 (15)	750 (51.6)	750 (51.6)	750 (51.6)	500 (34.4)
100 (37)	750 (51.6)	750 (51.6)	750 (51.6)	500 (34.4)
150 (65)	680 (46.8)	680 (46.8)	680 (46.8)	400 (27.5)
200 (93)	600 (41.3)	600 (41.3)	600 (41.3)	350 (24.1)
250 (121)	520 (35.8)	520 (35.8)	520 (35.8)	300 (20.6)
300 (148)	440 (30.3)	440 (30.3)	440 (30.3)	—
350 (176)	360 (24.8)	—	360 (24.8)	—
400 (204)	300 (20.6)	—	300 (20.6)	—
500 (260)	—	—	150 (10.3)	—
	Uncoupled and When Coupling and Uncoupling			
70 (20)	250 (17.2)			

### QC6 Series

Material	316 SS			Brass
O-Ring Material	Fluorocarbon FKM	Ethylene propylene	Perfluoro-carbon FFKM	Buna N
Temperature °F (°C)	Pressure Rating, psig(bar)			
	Coupled			
-50 (-45)	—	1500 (103)	—	—
0 (-17)	1500 (103)	1500 (103)	1500 (103)	1000 (68.9)
10 (-12)	1500 (103)	1500 (103)	1500 (103)	1000 (68.9)
60 (15)	1500 (103)	1500 (103)	1500 (103)	1000 (68.9)
100 (37)	1500 (103)	1500 (103)	1500 (103)	1000 (68.9)
150 (65)	1350 (93.0)	1350 (93.0)	1350 (93.0)	700 (48.2)
200 (93)	1150 (79.2)	1150 (79.2)	1150 (79.2)	450 (31.0)
250 (121)	970 (66.8)	970 (66.8)	970 (66.8)	300 (20.6)
300 (148)	750 (51.6)	750 (51.6)	750 (51.6)	—
350 (176)	580 (39.9)	—	580 (39.9)	—
400 (204)	400 (27.5)	—	400 (27.5)	—
500 (260)	—	—	150 (10.3)	—
	Uncoupled and When Coupling and Uncoupling			
70 (20)	250 (17.2)			

## Dimensions

### SESO Stems

#### Tube Fitting

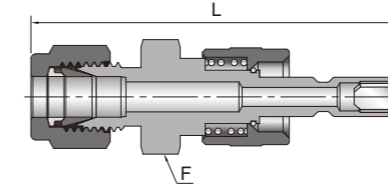

#### Male NPT

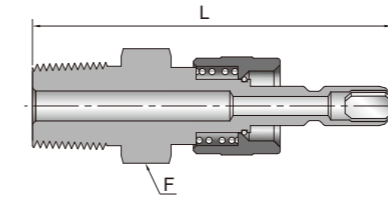

#### Female NPT

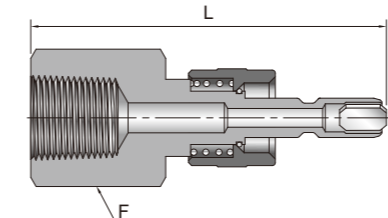

#### Male BSPT

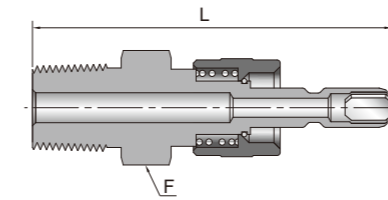

#### Female BSPT

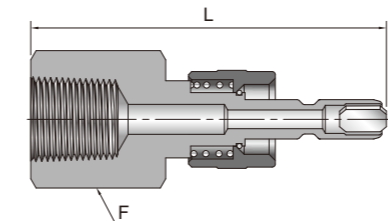

#### Male JIC(AN) 37° Flare

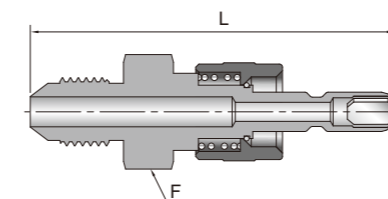

Fitting Size in.	Basic Ordering Number	Flow Coefficient (Cv)	Dimensions	
			F in.	L in. (mm)
1/8	-QC4-F2-S	0.08	5/8	2.32 (58.9)
1/4	-QC4-F4-S	0.3	5/8	2.36 (59.9)
3/8	-QC6-F6-S	1.0	3/4	2.52 (64.0)
1/2	-QC8-F8-S	2.4	15/16	2.96 (75.2)
mm	—	—	mm	mm (in.)
6	-QC4-F6M-S	0.3	16	59.9 (2.36)
10	-QC6-F10M-S	1.0	19	67.3 (2.65)
12	-QC8-F12M-S	2.4	24	75.2 (2.96)

NPT Size in.	Basic Ordering Number	Flow Coefficient (Cv)	Dimensions	
			F in.	L in. (mm)
1/8	-QC4-N2-S	0.3	5/8	2.07 (52.6)
1/4	-QC4-N4-S	0.3	5/8	2.22 (56.4)
1/4	-QC6-N4-S	0.8	3/4	2.32 (58.9)
3/8	-QC6-N6-S	0.8	3/4	2.35 (59.7)
1/2	-QC8-N8-S	2.0	15/16	2.84 (72.1)

NPT Size in.	Basic Ordering Number	Flow Coefficient (Cv)	Dimensions	
			F in.	L in. (mm)
1/8	-QC4-FN2-S	0.3	5/8	2.01 (51.1)
1/4	-QC4-FN4-S	0.3	3/4	2.26 (57.4)
1/4	-QC6-FN4-S	0.8	3/4	2.35 (59.7)
3/8	-QC6-FN6-S	0.8	7/8	2.35 (59.7)
1/2	-QC8-FN8-S	2.0	1 1/16	2.82 (71.6)

BSPT Size in.	Basic Ordering Number	Flow Coefficient (Cv)	Dimensions	
			F in.	L in. (mm)
1/8	-QC4-RT2-S	0.3	5/8	2.07 (52.6)
1/4	-QC4-RT4-S	0.3	5/8	2.22 (56.4)
1/4	-QC6-RT4-S	0.8	3/4	2.32 (58.9)
3/8	-QC6-RT6-S	0.8	3/4	2.35 (59.7)
1/2	-QC8-RT8-S	2.0	15/16	2.84 (72.1)

BSPT Size in.	Basic Ordering Number	Flow Coefficient (Cv)	Dimensions	
			F in.	L in. (mm)
1/8	-QC4-FRT2-S	0.3	5/8	2.01 (51.1)
1/4	-QC4-FRT4-S	0.3	3/4	2.26 (57.4)
1/4	-QC6-FRT4-S	0.8	3/4	2.35 (59.7)
3/8	-QC6-FRT6-S	0.8	7/8	2.35 (59.7)
1/2	-QC8-FRT8-S	2.0	1 1/16	2.82 (71.6)

Fitting Size in.	Basic Ordering Number	Flow Coefficient (Cv)	Dimensions	
			F in.	L in. (mm)
1/4	-QC4-AN4-S	0.2	5/8	2.23 (56.6)
3/8	-QC6-AN6-S	1.0	3/4	2.35 (59.7)
1/2	-QC8-AN8-S	2.4	15/16	2.79 (70.9)

**Hose Connector**

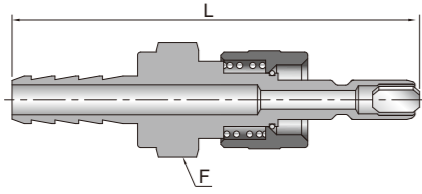

Hose Size in.	Basic Ordering Number	Flow Coefficient (Cv)	Dimensions	
			F in.	L in. (mm)
1/4	-QC4-HC4-S	0.2	5/8	2.47 (62.7)
3/8	-QC6-HC6-S	1.0	3/4	2.66 (67.6)
1/2	-QC8-HC8-S	2.4	15/16	3.07 (78.0)

**Bulkhead Tube Fitting**

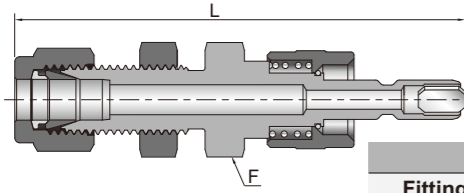

Fitting Size in.	Basic Ordering Number	Flow Coefficient (Cv)	Dimensions		Min. Panel Orifice in. (mm)	Max. Panel Thickness in. (mm)
			F in.	L in. (mm)		
1/4	-QC4-BF4-S	0.3	5/8	2.74 (69.6)	0.47 (11.9)	0.25 (6.4)
3/8	-QC6-BF6-S	1.0	3/4	2.92 (74.2)	0.60 (15.2)	0.27 (6.9)
1/2	-QC8-BF8-S	2.4	15/16	3.43 (87.1)	0.78 (19.8)	0.26 (6.6)
mm	—	—	mm	mm (in.)	mm (in.)	mm (in.)
6	-QC4-BF6M-S	0.3	16	69.6 (2.74)	11.7 (0.46)	6.4 (0.25)
10	-QC6-BF10M-S	1.0	22	77.7 (3.06)	16.8 (0.66)	6.9 (0.27)
12	-QC8-BF12M-S	2.4	24	87.1 (3.43)	19.6 (0.77)	6.6 (0.26)

**DESO Stems**

**Tube Fitting**

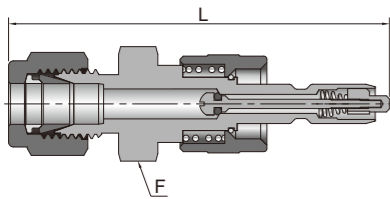

Fitting Size in.	Basic Ordering Number	Flow Coefficient (Cv)	Dimensions	
			F in.	L in. (mm)
1/8	-QC4-F2-D	0.08	5/8	2.77 (70.4)
1/4	-QC4-F4-D	0.2	5/8	2.42 (61.5)
3/8	-QC6-F6-D	0.5	3/4	2.64 (67.1)
1/2	-QC8-F8-D	1.5	15/16	3.16 (80.3)
mm	—	—	mm	mm (in.)
6	-QC4-F6M-D	0.2	16	61.5 (2.42)
10	-QC6-F10M-D	0.5	19	70.4 (2.77)
12	-QC8-F12M-D	1.5	24	80.3 (3.16)

**Male NPT**

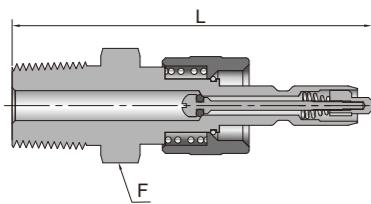

NPT Size in.	Basic Ordering Number	Flow Coefficient (Cv)	Dimensions	
			F in.	L in. (mm)
1/8	-QC4-N2-D	0.2	5/8	2.13 (54.1)
1/4	-QC4-N4-D	0.2	5/8	2.28 (57.8)
1/4	-QC6-N4-D	0.5	3/4	2.44 (61.9)
3/8	-QC6-N6-D	0.5	3/4	2.47 (62.7)
1/2	-QC8-N8-D	1.3	15/16	3.04 (77.2)

**Female NPT**

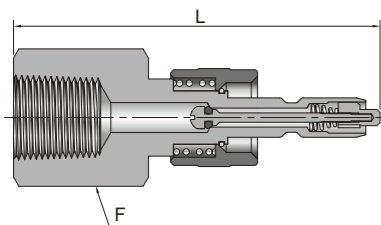

NPT Size in.	Basic Ordering Number	Flow Coefficient (Cv)	Dimensions		Min. Panel Orifice in. (mm)	Max. Panel Thickness in. (mm)
			F in.	L in. (mm)		
1/8	-QC4-FN2-D	0.2	5/8	2.07 (52.6)	0.47 (11.9)	0.25 (6.4)
1/4	-QC4-FN4-D	0.2	3/4	2.32 (58.9)	0.60 (15.2)	0.27 (6.9)
1/4	-QC6-FN4-D	0.5	3/4	2.47 (62.7)	0.78 (19.8)	0.26 (6.6)
3/8	-QC6-FN6-D	0.5	7/8	2.47 (62.7)	11.7 (0.46)	6.4 (0.25)
1/2	-QC8-FN8-D	1.3	1 1/16	3.04 (77.2)	16.8 (0.66)	6.9 (0.27)

**Male BSPT**

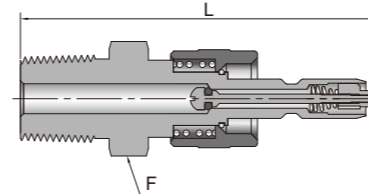

BSPT Size in.	Basic Ordering Number	Flow Coefficient (Cv)	Dimensions	
			F in.	L in. (mm)
1/8	-QC4-RT2-D	0.2	5/8	2.13 (54.1)
1/4	-QC4-RT4-D	0.2	5/8	2.28 (57.8)
1/4	-QC6-RT4-D	0.5	3/4	2.44 (61.9)
3/8	-QC6-RT6-D	0.5	3/4	2.47 (62.7)
1/2	-QC8-RT8-D	1.3	15/16	3.04 (77.2)

**Female BSPT**

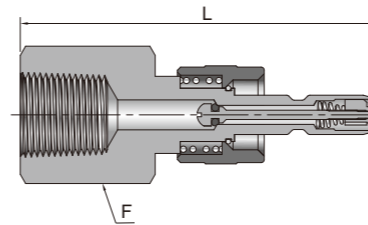

BSPT Size in.	Basic Ordering Number	Flow Coefficient (Cv)	Dimensions	
			F in.	L in. (mm)
1/8	-QC4-FRT2-D	0.2	5/8	2.07 (52.6)
1/4	-QC4-FRT4-D	0.2	3/4	2.32 (58.9)
1/4	-QC6-FRT4-D	0.5	3/4	2.47 (62.7)
3/8	-QC6-FRT6-D	0.5	7/8	2.47 (62.7)
1/2	-QC8-FRT8-D	1.3	1 1/16	3.04 (77.2)

**Male JIC(AN) 37° Flare**

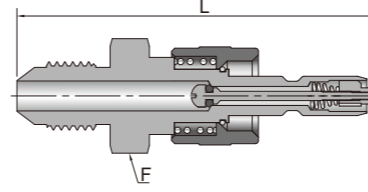

Fitting Size in.	Basic Ordering Number	Flow Coefficient (Cv)	Dimensions	
			F in.	L in. (mm)
1/4	-QC4-AN4-D	0.2	5/8	2.29 (58.2)
3/8	-QC6-AN6-D	0.5	3/4	2.47 (62.7)
1/2	-QC8-AN8-D	1.5	15/16	2.99 (75.9)

**Hose Connector**

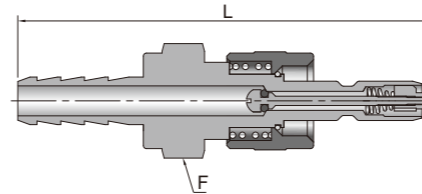

Hose Size in.	Basic Ordering Number	Flow Coefficient (Cv)	Dimensions	
			F in.	L in. (mm)
1/4	-QC4-HC4-D	0.2	5/8	2.53 (64.3)
3/8	-QC6-HC6-D	0.5	3/4	2.78 (70.6)
1/2	-QC8-HC8-D	1.5	15/16	3.27 (83.1)

**Bulkhead Tube Fitting**

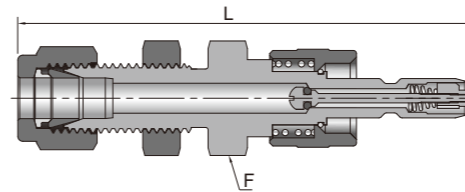

Fitting Size in.	Basic Ordering Number	Flow Coefficient (Cv)	Dimensions		Min. Panel Orifice in. (mm)	Max. Panel Thickness in. (mm)
			F in.	L in. (mm)		
1/4	-QC4-BF4-D	0.2	5/8	2.80 (71.1)	0.47 (11.9)	0.25 (6.4)
3/8	-QC6-BF6-D	0.5	3/4	3.07 (78.0)	0.60 (15.2)	0.27 (6.9)
1/2	-QC8-BF8-D	1.5	15/16	3.63 (92.2)	0.78 (19.8)	0.26 (6.6)
mm	—	—	mm	mm (in.)	mm (in.)	mm (in.)
6	-QC4-BF6M-D	0.2	16	71.1 (2.80)	11.7 (0.46)	6.4 (0.25)
10	-QC6-BF10M-D	0.5	22	78.7 (3.10)	16.8 (0.66)	6.9 (0.27)
12	-QC8-BF12M-D	1.5	24	92.2 (3.63)	19.6 (0.77)	6.6 (0.26)

**Bodies**

**Tube Fitting**

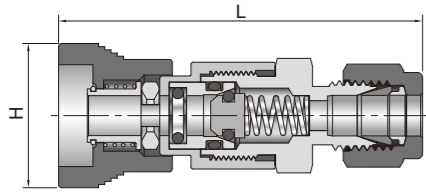

**Male NPT**

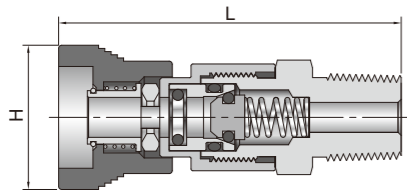

**Female NPT**

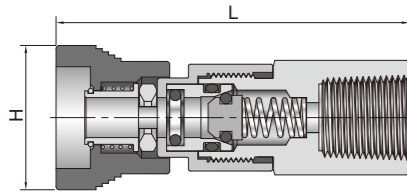

**Male BSPT**

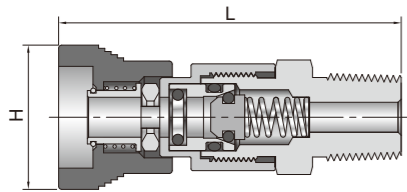

**Female BSPT**

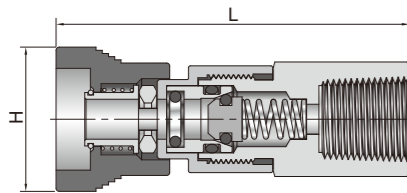

**Male JIC (AN) 37° Flare**

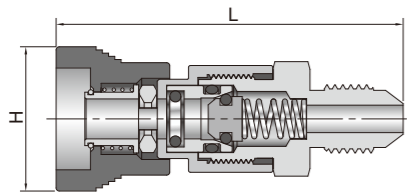

Fitting Size in.	Basic Ordering Number	Dimensions	
		H in.	L in. (mm)
1/8	-QC4-F2-B	0.91 (23.1)	2.26 (57.4)
1/4	-QC4-F4-B	0.91 (23.1)	2.30 (58.4)
3/8	-QC6-F6-B	1.03 (26.2)	2.58 (65.5)
1/2	-QC8-F8-B	1.21 (30.7)	3.09 (78.5)
mm		mm (in.)	mm (in.)
6	-QC4-F6M-B	23.1 (0.91)	58.4 (2.30)
10	-QC6-F10M-B	26.2 (1.03)	68.1 (2.68)
12	-QC8-F12M-B	30.7 (1.21)	78.5 (3.09)

NPT Size in.	Basic Ordering Number	Dimensions	
		H in.	L in. (mm)
1/8	-QC4-N2-B	0.91 (23.1)	2.01 (51.1)
1/4	-QC4-N4-B	0.91 (23.1)	2.16 (54.9)
1/4	-QC6-N4-B	1.03 (26.2)	2.38 (60.5)
3/8	-QC6-N6-B	1.03 (26.2)	2.38 (60.5)
1/2	-QC8-N8-B	1.21 (30.7)	2.97 (75.4)

NPT Size in.	Basic Ordering Number	Dimensions	
		H in.	L in. (mm)
1/8	-QC4-FN2-B	0.91 (23.1)	2.16 (54.9)
1/4	-QC4-FN4-B	0.91 (23.1)	2.42 (61.5)
1/4	-QC6-FN4-B	1.03 (26.2)	2.54 (64.5)
3/8	-QC6-FN6-B	1.03 (26.2)	2.57 (65.3)
1/2	-QC8-FN8-B	1.21 (30.7)	3.22 (81.8)

BSPT Size in.	Basic Ordering Number	Dimensions	
		H in.	L in. (mm)
1/8	-QC4-RT2-B	0.91 (23.1)	2.01 (51.1)
1/4	-QC4-RT4-B	0.91 (23.1)	2.16 (54.9)
1/4	-QC6-RT4-B	1.03 (26.2)	2.38 (60.5)
3/8	-QC6-RT6-B	1.03 (26.2)	2.38 (60.5)
1/2	-QC8-RT8-B	1.21 (30.7)	2.97 (75.4)

BSPT Size in.	Basic Ordering Number	Dimensions	
		H in.	L in. (mm)
1/8	-QC4-FRT2-B	0.91 (23.1)	2.16 (54.9)
1/4	-QC4-FRT4-B	0.91 (23.1)	2.42 (61.5)
1/4	-QC6-FRT4-B	1.03 (26.2)	2.54 (64.5)
3/8	-QC6-FRT6-B	1.03 (26.2)	2.57 (65.3)
1/2	-QC8-FRT8-B	1.21 (30.7)	3.22 (81.8)

Fitting Size in.	Basic Ordering Number	Dimensions	
		H in.	L in. (mm)
1/4	-QC4-AN4-B	0.91 (23.1)	2.17 (55.1)
3/8	-QC6-AN6-B	1.03 (26.2)	2.41 (61.2)
1/2	-QC8-AN8-B	1.21 (30.7)	2.92 (74.2)

**Hose Connector**

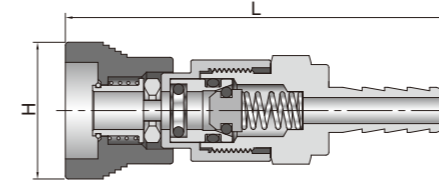

**Bulkhead Tube Fitting**

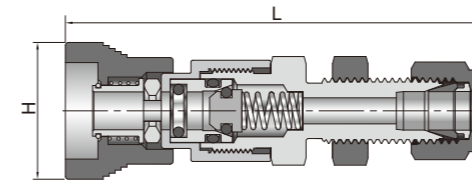

**Full-Fow Bodies**

**Tube Fitting**

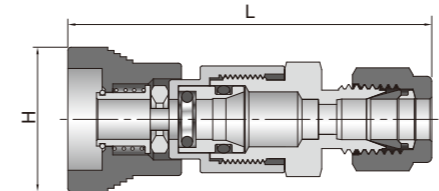

**Male NPT**

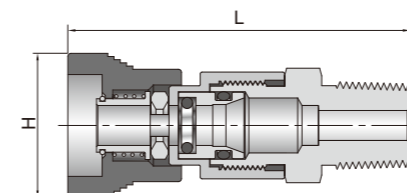

**Female NPT**

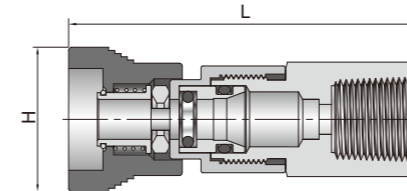

**Male BSPT**

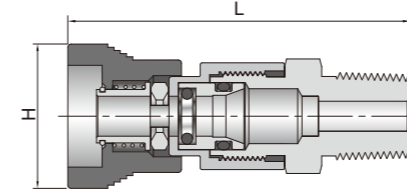

Hose Size in.	Basic Ordering Number	Dimensions	
		H in.	L in. (mm)
1/4	-QC4-HC4-B	0.91 (23.1)	2.41 (61.2)
3/8	-QC6-HC6-B	1.03 (26.2)	2.72 (69.1)
1/2	-QC8-HC8-B	1.21 (30.7)	3.20 (81.3)

Fitting Size in.	Basic Ordering Number	Dimensions		Min. Panel Orifice in. (mm)	Max. Panel Thickness in. (mm)
		H in.	L in. (mm)		
1/4	-QC4-BF4-B	0.91 (23.1)	2.67 (67.8)	0.47 (11.9)	0.25 (6.4)
3/8	-QC6-BF6-B	1.03 (26.2)	2.98 (75.7)	0.60 (15.2)	0.27 (6.9)
1/2	-QC8-BF8-B	1.21 (30.7)	3.56 (90.4)	0.78 (19.8)	0.26 (6.6)
mm		mm (in.)	mm (in.)	mm (in.)	mm (in.)
6	-QC4-BF6M-B	23.1 (0.91)	67.8 (2.67)	11.7 (0.46)	6.4 (0.25)
10	-QC6-BF10M-B	26.2 (1.03)	75.9 (2.99)	16.8 (0.66)	6.9 (0.27)
12	-QC8-BF12M-B	30.7 (1.21)	90.4 (3.56)	19.6 (0.77)	6.6 (0.26)

Fitting Size in.	Basic Ordering Number	Dimensions	
		H in.	L in. (mm)
1/8	-QC4-F2-F	0.91 (23.1)	2.26 (57.4)
1/4	-QC4-F4-F	0.91 (23.1)	2.30 (58.4)
3/8	-QC6-F6-F	1.03 (26.2)	2.58 (65.5)
1/2	-QC8-F8-F	1.21 (30.7)	3.09 (78.5)
mm		mm (in.)	mm (in.)
6	-QC4-F6M-F	23.1 (0.91)	58.4 (2.30)
10	-QC6-F10M-F	26.2 (1.03)	68.1 (2.68)
12	-QC8-F12M-F	30.7 (1.21)	78.5 (3.09)

NPT Size in.	Basic Ordering Number	Dimensions	
		H in.	L in. (mm)
1/8	-QC4-N2-F	0.91 (23.1)	2.01 (51.1)
1/4	-QC4-N4-F	0.91 (23.1)	2.16 (54.9)
1/4	-QC6-N4-F	1.03 (26.2)	2.38 (60.5)
3/8	-QC6-N6-F	1.03 (26.2)	2.38 (60.5)
1/2	-QC8-N8-F	1.21 (30.7)	2.97 (75.4)

NPT Size in.	Basic Ordering Number	Dimensions	
		H in.	L in. (mm)
1/8	-QC4-FN2-F	0.91 (23.1)	2.16 (54.9)
1/4	-QC4-FN4-F	0.91 (23.1)	2.42 (61.5)
1/4	-QC6-FN4-F	1.03 (26.2)	2.54 (65.4)
3/8	-QC6-FN6-F	1.03 (26.2)	2.57 (65.3)
1/2	-QC8-FN8-F	1.21 (30.7)	3.22 (81.8)

BSPT Size in.	Basic Ordering Number	Dimensions	
		H in.	L in. (mm)
1/8	-QC4-RT2-F	0.91 (23.1)	2.01 (51.1)
1/4	-QC4-RT4-F	0.91 (23.1)	2.16 (54.9)
1/4	-QC6-RT4-F	1.03 (26.2)	2.38 (60.5)
3/8	-QC6-RT6-F	1.03 (26.2)	2.38 (60.5)
1/2	-QC8-RT8-F	1.21 (30.7)	2.97 (75.4)

**Female BSPT**

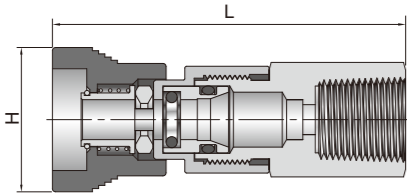

**Male JIC (AN) 37° Flare**

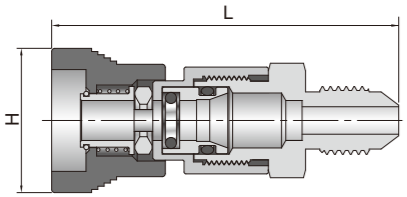

**Hose Connector**

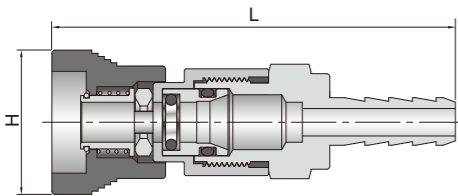

**Bulkhead Tube Fitting**

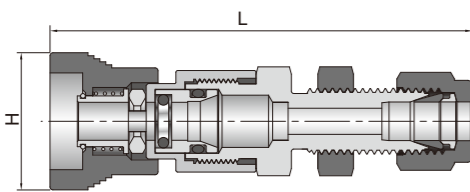

BSPT Size in.	Basic Ordering Number	Dimensions	
		H in.	L in. (mm)
1/8	-QC4-FRT2-F	0.91 (23.1)	2.16 (54.9)
1/4	-QC4-FRT4-F	0.91 (23.1)	2.42 (61.5)
1/4	-QC6-FRT4-F	1.03 (26.2)	2.54 (64.5)
3/8	-QC6-FRT6-F	1.03 (26.2)	2.57 (65.3)
1/2	-QC8-FRT8-F	1.21 (30.7)	3.22 (81.8)

Fitting Size in.	Basic Ordering Number	Dimensions	
		H in.	L in. (mm)
1/4	-QC4-AN4-F	0.91 (23.1)	2.17 (55.1)
3/8	-QC6-AN6-F	1.03 (26.2)	2.41 (61.2)
1/2	-QC8-AN8-F	1.21 (30.7)	2.92 (74.2)

Hose Size in.	Basic Ordering Number	Dimensions	
		H in.	L in. (mm)
1/4	-QC4-HC4-F	0.91 (23.1)	2.41 (61.2)
3/8	-QC6-HC6-F	1.03 (26.2)	2.72 (69.1)
1/2	-QC8-HC8-F	1.21 (30.7)	3.20 (81.3)

Fitting Size in.	Basic Ordering Number	Dimensions		Min. Panel Orifice in. (mm)	Max. Panel Thickness in. (mm)
		H in.	L in. (mm)		
1/4	-QC4-BF4-F	0.91 (23.1)	2.67 (67.8)	0.47 (11.9)	0.25 (6.4)
3/8	-QC6-BF6-F	1.03 (26.2)	2.98 (75.7)	0.60 (15.2)	0.27 (6.9)
1/2	-QC8-BF8-F	1.21 (30.7)	3.56 (90.4)	0.78 (19.8)	0.26 (6.6)
mm		mm (in.)	mm (in.)	mm (in.)	mm (in.)
6	-QC4-BF6M-F	23.1 (0.91)	67.8 (2.67)	11.7 (0.46)	6.4 (0.25)
10	-QC6-BF10M-F	26.2 (1.03)	75.9 (2.99)	16.8 (0.66)	6.9 (0.27)
12	-QC8-BF12M-F	30.7 (1.21)	90.4 (3.56)	19.6 (0.77)	6.6 (0.26)

**Options, QC Series**

**Keyed QC Series**

XINVAL keyed quick-connects provide a reliable mechanical lockout system to prevent accidental intermixing of different lines in multifluid or multipressure systems.

**QC Series Key Numbers and Sleeve Outside Diameters**

Key Number	Color	QC4		QC6		QC8	
		Body Sleeve	Stem Sleeve	Body Sleeve	Stem Sleeve	Body Sleeve	Stem Sleeve
		in. (mm)	in. (mm)	in. (mm)	in. (mm)	in. (mm)	in. (mm)
K1	Black	0.96 (24.4)	0.82 (20.8)	1.13 (28.7)	0.99 (25.1)	1.26 (32.0)	1.10 (27.9)
K2	Orange	0.99 (25.1)	0.85 (21.6)	1.16 (29.5)	1.02 (25.9)	1.29 (32.8)	1.14 (29.0)
K3	Green	1.02 (25.9)	0.88 (22.4)	1.19 (30.2)	1.05 (26.7)	1.32 (33.5)	1.17 (29.7)
K4	Yellow	1.05 (26.7)	0.91 (23.1)	1.22 (31.0)	1.08 (27.4)	1.35 (34.3)	1.20 (30.5)
K5	Blue	1.08 (27.4)	0.94 (23.9)	1.24 (31.5)	1.11 (28.2)	1.38 (35.1)	1.23 (31.2)
K6	White	1.11 (28.2)	0.97 (24.6)	1.28 (32.5)	1.14 (29.0)	1.41 (35.8)	1.26 (32.0)
K7	Purple	1.14 (29.0)	1.00 (25.4)	1.31 (33.3)	1.17 (29.7)	1.44 (36.6)	1.29 (32.8)
K8	Brown	1.17 (29.7)	1.03 (26.2)	1.34 (34.0)	1.20 (30.5)	1.47 (37.3)	1.32 (33.5)

**Stem and Body Protector**

Stem and body protector can prevent the stem and the body from being damaged and polluted when uncoupling.

**Stem Protector**

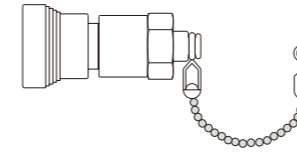

Series	Basic Ordering Number
QC4	-QC4-SP
QC6	-QC6-SP
QC8	-QC8-SP

**Body Protector**

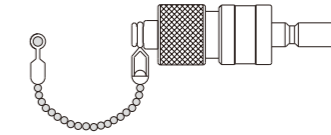

Series	Basic Ordering Number
QC4	-QC4-BP
QC6	-QC6-BP
QC8	-QC8-BP

- Ordering number description of the protector: material designator (316 refers to 316 stainless steel) + basic ordering number. Example: **316-QC4-BP**
- Ordering number description of the keyed protector: material designator (316 refers to 316 stainless steel) + basic ordering number+key number. Example: **316-QC4-BP-K2**
- The protector is not a pressure sustaining device. To order pressure sustaining device, please contact XINVAL Group or our authorized distributors.

**Ordering Number Description**

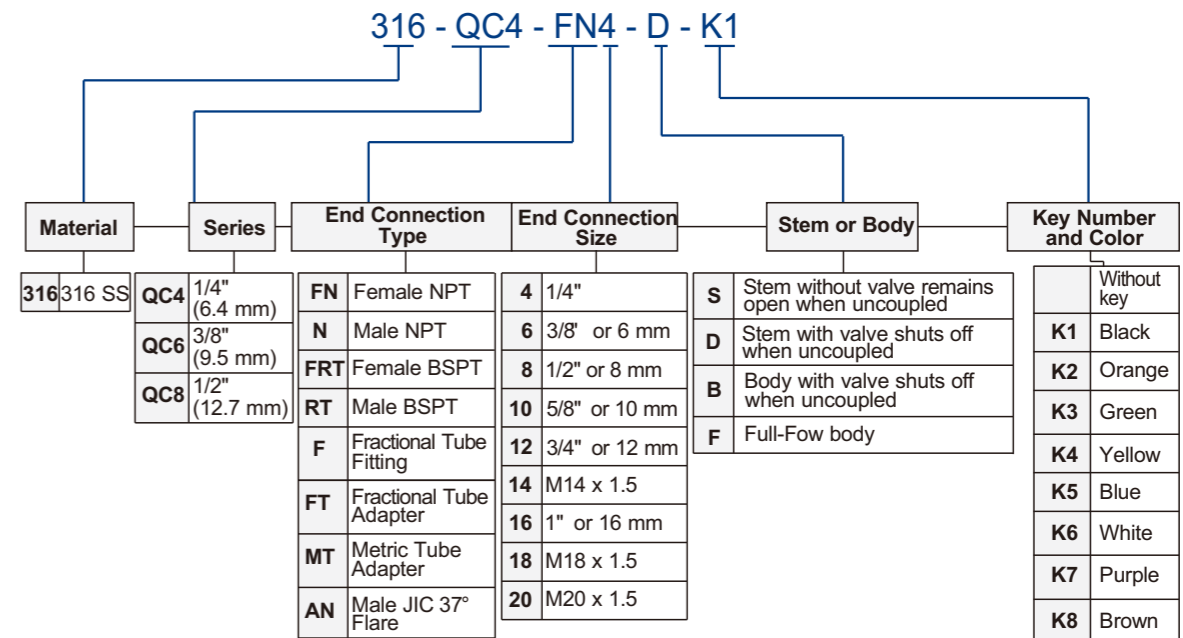

Note: 1. "Ordering Number Description" is a reference to understand the combination rules of XINVAL product part number. Not all combinations are available.  
2. Dimensions are for reference only and are subject to change.